

OPERATORS' GUIDE

PDY-6.6-Series 6 TON HYDRAULIC CRIMPING HEAD



⚠ CAUTION

Do not operate
without dies.

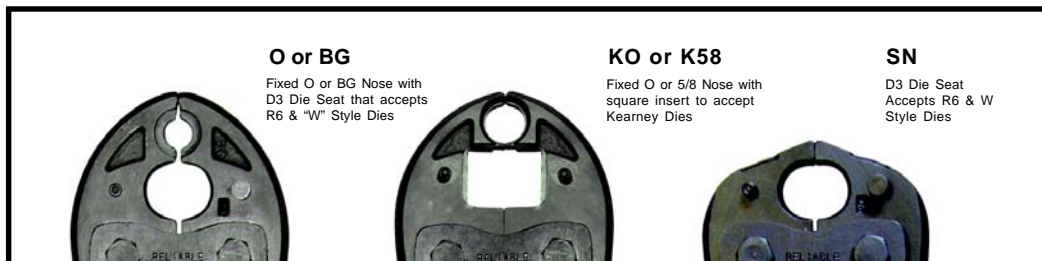

O or BG

Fixed O or BG Nose with
D3 Die Seat that accepts
R6 & "W" Style Dies

KO or K58

Fixed O or 5/8 Nose with
square insert to accept
Kearney Dies

SN

D3 Die Seat
Accepts R6 & W
Style Dies



RELIABLE EQUIPMENT & SERVICE CO., INC.

92 Steamwhistle Drive • Ivyland, PA 18974 • USA
Phone: 215-357-3500 • Fax: 215-357-9193

MODEL: _____

MAX. PRESSURE: _____

SERIAL NO.: _____

YEAR: _____

WARNING



All information found in this guide
must be read and understood before
use or testing of this tool.

Failure to read and understand these warnings
and safe handling instructions could result
in severe personal injury and or death.

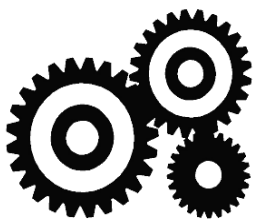

RELIABLE EQUIPMENT & SERVICE CO., INC.

DISTRIBUTED BY

REGISTRATION

UPON RECEIPT OF THIS TOOL, COMPLETE THE REGISTRATION BELOW.

COMPANY _____

ADDRESS _____

PHONE _____ FAX _____

SERIAL NUMBER _____

DATE OF PURCHASE _____

DEALER NAME _____

TABLE OF CONTENTS

DISTRIBUTOR INFORMATION	2
REGISTRATION	3
TABLE OF CONTENTS	3
TOOL SPECIFICATIONS	4
DOUBLE ACTING TOOL OVERVIEW	5
CONTROL VALVE INFORMATION	6
SAFETY INFORMATION AND WARNINGS	7-11
OPERATING INSTRUCTIONS	12
DAILY & GENERAL MAINTENANCE	13
PARTS LIST	14
PARTS DIAGRAM	15
LABELS	16
MAINTENANCE RECORDS	16
CONTACT INFORMATION	16



THIS SYMBOL INDICATES ITEMS OF EXTREME IMPORTANCE.

Safety of user and others may be in jeopardy if these instructions are not read and understood.



CAUTION

The information in this manual is intended to guide the user in the use and application of this tool. It is not intended as a substitute for proper training and experience in safe work practices for this type of equipment.

Consult your supervisor or safety personnel if you have any questions regarding the safe operation of this tool.

If you have any questions regarding the information found in this manual please contact the supervising authority, or **RELIABLE EQUIPMENT** before continuing.
Phone: 215-357-3500 • Toll Free: 800-966-3530 • Fax: 215-357-9193



RELIABLE EQUIPMENT & SERVICE CO., INC.

PDY-6.6-Series 6 TON HYDRAULIC CRIMPING HEAD

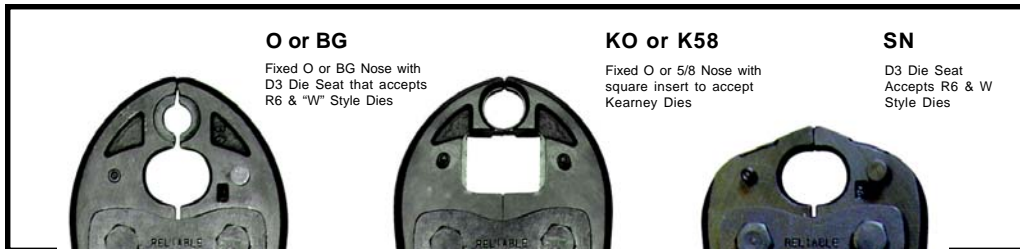

O or BG
Fixed O or BG Nose with
D3 Die Seat that accepts
R6 & "W" Style Dies

KO or K58
Fixed O or 5/8 Nose with
square insert to accept
Kearney Dies

SN
D3 Die Seat
Accepts R6 & W
Style Dies



PDY 6.6 TON DOUBLE ACTING HYDRAULIC CRIMPING TOOLS

This 6.6 ton crimping head installs a full range of connectors from #14 through 4/0. The PDY-6.6 will accept all existing Reliable R6 and "W" style dies. Spring die retainer pins assure positive die positioning. The forged steel head construction and butting jaw design will provide years of reliable, accurate performance under the extreme demands required by the industry.

Each PDY-6.6 features a central die seat and a permanent nose configuration to simplify standard field operations.

The double acting system virtually eliminates die hang-up when used in combination with the PVA-1122 control valve.

MODEL

PDY-6.6-BG	D3 SEAT & FIXED BG NOSE
PDY-6.6-O	D3 SEAT & FIXED O NOSE
PDY-6.6-K-58	KEARNEY SEAT & K-58 NOSE
PDY-6.6-KO	KEARNEY SEAT & KO NOSE
PDY-6.6-SN	D3 SEAT ONLY

SPECIFICATIONS

System	Double Acting
Capacity	#14 through 4/0
Crimp @ 10,000 psi	6.6 ton
Max. Oper. Pressure	10,000 psi
Weight	7.6 lbs.
Length	13.25 inch
Width	4.5 in. (Open)
Couplers	Direct Connect
Dies Accepted	R6 and "W" Style

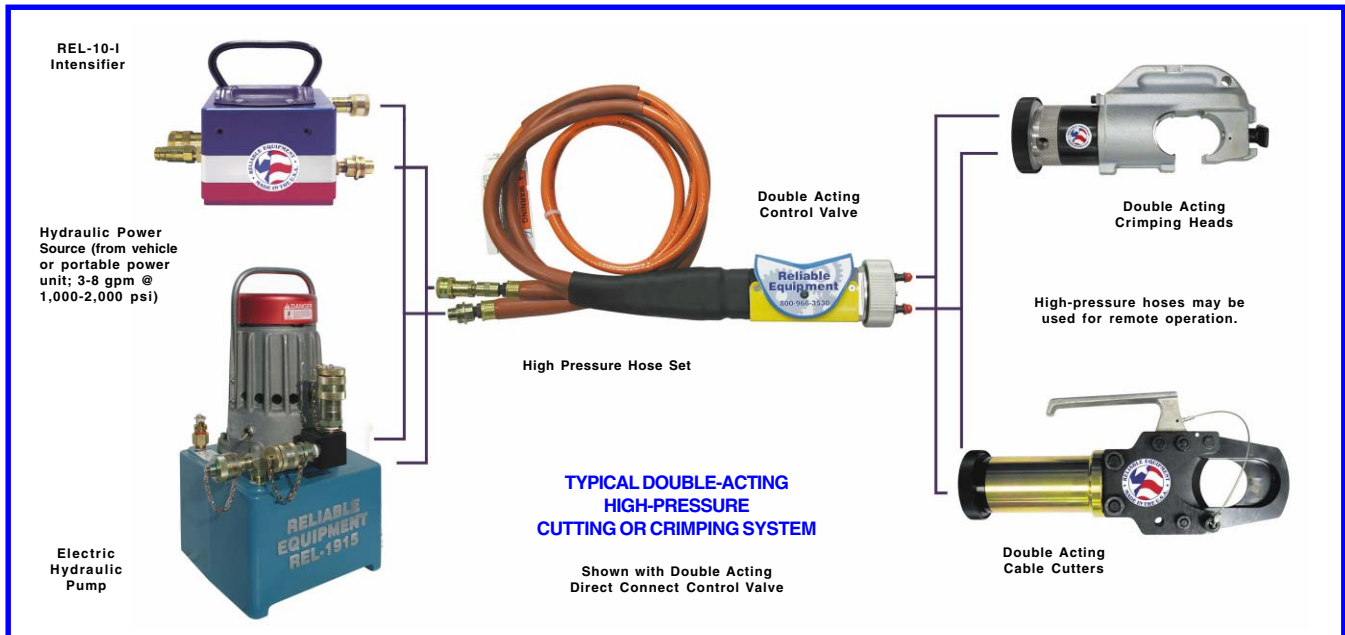

DOUBLE-ACTING TOOLS ARE BUILT TO PROVIDE SAFETY, QUALITY AND RELIABILITY IN EVERY STEP OF HIGH PRESSURE TOOL OPERATION.

In most cases, double-acting tools are lighter and more compact than comparable crimping and cutting equipment, insuring easier and safer use. This is especially important in compact working areas and hot stick use when every ounce of a tool's weight is felt by the operator.

The one-hand valve operation is safer and easier to use, leaving your other hand free to control the tool head. Each valve has two pressure reliefs for extra safety: One to reduce the return cycle pressure to prevent damage to the tool; The second to protect against over pressurizing.

DOUBLE-ACTING HYDRAULIC SYSTEM

Superior Performance - beats competitive power tool systems on key features and benefits.

Better tool control - start, stop, feather, and position your crimping or cutting head with ease.

No die hang-ups - crisply retracts the die after every crimp.

Compatible with many existing tool and die inventories or convert your existing tools and dies to our double-acting system.

Consistent Pressure - Delivers up to 10,000 psi at tool head, regardless of positioning.

Quality Features - Lightweight, built-in pressure reliefs; ground dumps; scavenger pump reduces back-pressure problems; one-hand valve operation; and certified non-conductive hoses.

Portability - Lighter and more streamlined than most other tools.

Adaptability - Use Reliable tools with your truck's existing system or one of our portable power units.

VALVES

Reliable valves feature one-hand operation for extreme ease of use. They can be direct-coupled to the tool or, if you wish, attached with hoses for remote operation. In addition, they feature a built-in relief valve to limit tool return pressure and a ground dump safety valve to prevent over pressurizing in case the return hose becomes disconnected or plugged.

CRIMPING HEADS

In many cases, double-acting crimping heads are significantly lighter than competitive models. Safety is designed-in as well. One example: A pressure reducing cavity is designed into each head to reduce the risk of personal injury from a high-pressure oil leak.

CUTTERS

All cutters are double-acting and available in capacities from 1/2 in. to 4 in. Some models can handle a wide range of materials, including rebar, ACSR, guy strand, and bolts. Other safety features include hoses rated at four times the working pressure, and dielectrically safe hoses.

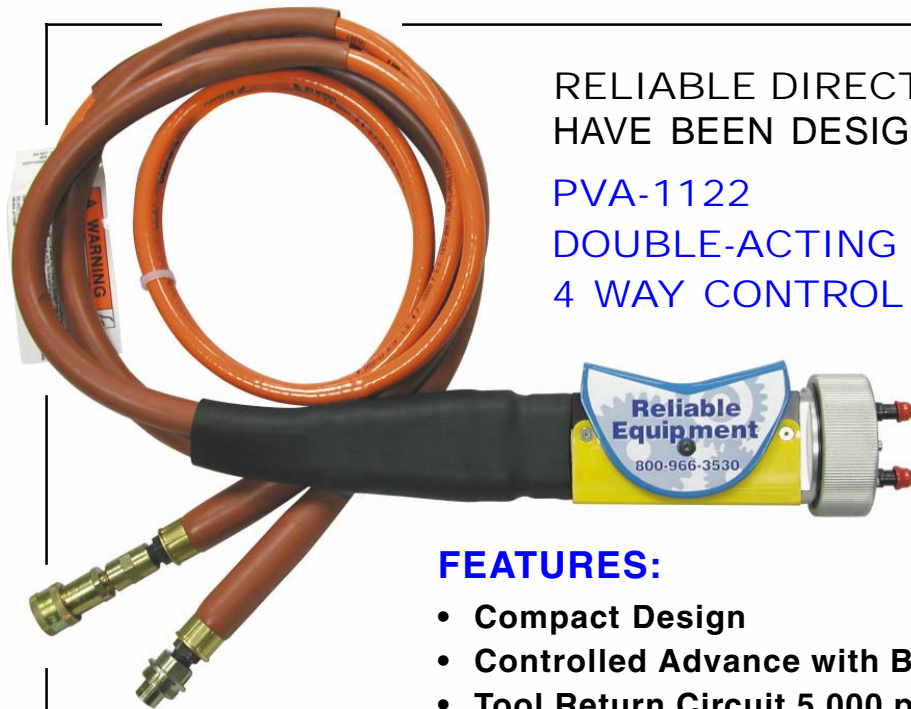

RELIABLE DIRECT CONNECT HEADS
 HAVE BEEN DESIGNED FOR USE WITH
PVA-1122
DOUBLE-ACTING DIRECT CONNECT
4 WAY CONTROL VALVE

FEATURES:

- **Compact Design**
- **Controlled Advance with Built-in Hold Feature**
- **Tool Return Circuit 5,000 psi Return Line**
- **6,200 psi Return Line Ground Dump Safety Valve**

Open center 4-way, 3-position control valve used for controlling double-acting Crimping Heads and Cutters. Connect directly to the tool or use with high pressure hoses for remote operation. The Pivot Style Control Valve may be operated with one hand, leaving the second hand free to control the head.

Lever “locks” in the forward position for tool advance, and in the rear position for tool retraction. Returns automatically to center “OFF” position when rated tool pressure is reached.

The Ground Dump Safety Valve, a standard feature, will activate if the return line is not connected. It protects the system by dumping the flow into the atmosphere.

SPECIFICATIONS	PVA 0022	PVA 1122	Dimensions:
System	Double-Acting	Double-Acting	Length: 7 in.
Max. Oper. Pressure	10,000 psi	10,000 psi	Width: 2 in.
Return Pressure	5,000 psi	5,000 psi	Height: 3.5in.
Port Size (Inlet)	1/4-18 NPTF	1/4-18 NPTF	Weight: 2.5 lb.
Port Size (Tool)	1/4-18 NPSM	1/4-18 NPSM	PVA 1122 is 3 lb. W/ Coupler
Couplers	H/P 10,000 psi Quick Connect	Direct Connect	

NOTE: Any of the **RELIABLE** direct connect tool heads may also be used with the PVA 0022 or comparable 4 way control valve with the addition of a set of high pressure couplers.



WARNING

BEFORE USING THIS TOOL, READ THE WARNINGS and the recommended practices described in this manual. Failure by the operator to read and fully understand these warnings will leave this person unqualified to use and operate this tool. Property damage, severe personal injury, and/or death could result by not following these warnings.

These warnings will appear in appropriate locations when they are pertinent to the particular subject being shown. Read each one carefully and follow them strictly.



Eye Protection

WARNING

Always wear eye protection to avoid injury from flying debris or hydraulic oil leaks. Failure to do so can result in serious personal injury.



Skin Irritation

WARNING

Hydraulic oil may cause irritation. Use care to prevent contact with skin. In case of accidental contact, wash affected area immediately



Hard Hat

WARNING

Always wear a hard hat to avoid injury from falling debris. Failure to do so can result in serious personal injury.



Foot Protection

WARNING

Always wear foot protection. Failure to do so can result in serious personal injury.



Hearing Protection

WARNING

Always wear hearing protection, to avoid hearing loss due to long term exposure to high noise levels.



Protective Gloves

WARNING

Always wear protective gloves Failure to do so can result in serious personal injury.



WARNING

SAFE OPERATION & CARE

USE THIS TOOL FOR ITS INTENDED PURPOSE ONLY
Any other use can result in injury or property damage.

INSPECT TOOL BEFORE USE. Replace any worn, damaged or missing parts. A damaged or improperly assembled tool may malfunction, injuring operator and/or nearby personnel.

INSPECT HYDRAULIC HOSES AND COUPLINGS before each use. Repair or replace if any cracking, leakage, wear or damage is found. Worn or damaged hoses may fail resulting in personal injury or property damage.

CLEAR WORK AREA of all bystanders and unnecessary personnel before operating this tool.

KEEP ALL PARTS OF THE BODY AWAY FROM MOVING PARTS.

Failure to observe this warning could result in serious injury.



WARNING

HYDRAULIC POWER SUPPLY

DO NOT attempt to make any changes to any of the component parts or accessories when connected to the power source.

DO NOT adjust, inspect, or clean tool while the tool is connected to the power source. The tool could accidentally start up and cause serious injury.

DO NOT lock the tool in the On Position. In an emergency, serious damage or injury could occur during the time required to stop the tool.



WARNING

OIL INJECTION INJURY

Hydraulic oil or fluid under the skin is a serious injury. Oil under pressure can penetrate the skin and may cause dismemberment or loss of life. Seek medical assistance immediately if such an injury should occur.

Always wear safety gloves, eye protection and all required safety equipment when operating or handling this tool.

DO NOT use fingers or hands to attempt to locate a leak.

DO NOT handle hoses or couplers while system is pressurized.

NEVER open or service the system before depressurizing.



WARNING

HOSES AND FITTINGS

There exists the potential for shock in using anything other than certified nonconductive hoses and hydraulic oil with dielectric properties, when using system components near energized electrical lines. Failure to recognize these conditions could cause electrocution.

Hoses and fittings used with this tool must comply with S.A.E. J1273 which covers recommended practice for selection, installation, and maintenance of hose and hose assemblies. The **correct hoses and fittings are available from your supplier.**

WARNING: Failure to comply with these warnings could result in severe bodily injury.



WARNING

UNIT/HOSE CONNECTIONS

ALWAYS DISCONNECT pump/power source and move toggle switch to **OFF** before connecting or disconnecting any components.

ALWAYS DEPRESSURIZE hydraulic system, before slowly disconnecting this unit or any of the systems components.

ALWAYS TIGHTEN couplings completely. Loose or improperly tightened couplings will not allow fluid to pass through the hose creating a blockage in the supply or return line.

ALWAYS INSPECT HOSES AND CONNECTORS before connection to tool. Replace or repair if any leakage is evident. Leakage is a sign of deterioration in component parts. Worn or leaking parts must be repaired or replaced, or tool damage or severe injury could result.



CAUTION

HOSE INSTALLATION

ALWAYS ENSURE CONNECTORS ARE CLEAN

DOUBLE ACTING - Care must be taken to assure the correct connection of the hoses to the pressure and return (tank) ports. Connect the return hose to the return (tank) port on the power source, then to the return port on the tool.

Connect the pressure hose to the pressure port on the tool, then to the "P" pressure port on the power source.

Operation with hydraulic flow reversed can cause malfunction. Failure to fully comply can result in severe injury or death.



WARNING

Operation/Safety methods may vary in accordance with the working guidelines established by each utility or contractor.

For your own safety, ensure that you fully comply with all safe operation guidelines required by your employer.



WARNING

ELECTRICAL SHOCK HAZARD

Always wear and use the necessary clothing, equipment and safety practices to protect against electrical shock. Failure to follow these rules can result in serious personal injury or death.



GENERAL SAFETY



USE ALL APPROPRIATE AND APPLICABLE PERSONAL SAFETY EQUIPMENT as required by the operating company.

ALWAYS INSPECT TOOL for wear or deterioration every day. Replace all parts that show signs of wear or damage.

KEEP ALL PARTS OF THE BODY AWAY from moving parts of the tool.

KEEP HANDS OUT FROM BETWEEN FIXED AND MOVING JAWS AT TOOL HEAD.

HANDS SHOULD BE OUTSIDE DANGER ZONE PRIOR TO ACTIVATING JAWS.

MAKE SURE there is no person in close proximity to you or the tool who could be injured by any operation being performed, tool malfunction or flying debris.

DO NOT OVEREXTEND your position by overreaching or unbalancing the footing necessary to maintain physical control of your body.

ALWAYS MAINTAIN a firm grip on the tool to avoid loss of control during an operation, causing property damage, serious injury or death.

USE THIS TOOL FOR THE MANUFACTURERS' INTENDED PURPOSE ONLY.

OBSERVE CLOSELY ALL SAFETY RULES FOR A PARTICULAR JOB CLASS

FAILURE TO HEED THESE WARNINGS COULD RESULT IN PROPERTY DAMAGE, SERIOUS PERSONAL INJURY OR DEATH.



WARNING

SERIOUS BURN HAZARD

HOT SURFACES MAY CAUSE SERIOUS BURNS.

The hydraulic cylinder may be hot during and after operation.

CAUTION: HYDRAULIC FLUID MAY CAUSE SERIOUS BURNS.

Never disconnect tool, hoses, or fittings while the hydraulic power source is running or if the hydraulic fluid is hot.

Failure to observe this warning could result in serious injury.



WARNING

CRIMP DANGER

This hydraulic crimping tool can crush and/or disable.

KEEP ALL PARTS OF THE BODY AWAY FROM MOVING PARTS.

DO NOT lock the tool in the On Position. In an emergency, serious damage or injury could occur during the time required to stop the tool.

Failure to observe this warning could result in serious injury



WARNING

TOOL HAZARD

DO NOT OPERATE TOOL WITHOUT DIES.

DO NOT EXCEED THE MAXIMUM HYDRAULIC FLOW, RELIEF PRESSURE, OR BACK PRESSURE.

Failure to observe warnings could result in tool damage or injury.



WARNING

FIRE HAZARD

An incomplete crimp may pose a fire hazard.

Always use the appropriate connector, die set, and compression tool, as required by the intended application.

Compression tool should be tested on a regular schedule to ensure accurate compression.

Failure to observe this warning could result in serious injury.

IF YOU HAVE ANY QUESTIONS REGARDING THE SAFE USE AND/OR OPERATION OF THIS TOOL, CONSULT YOUR AREA SUPERVISOR, OR CONTACT RELIABLE EQUIPMENT AT 800-966-3530

OPERATION

Read entire manual prior to using this tool.

(Refer to all safety recommendations and warnings)

Observe all safety precautions and procedures required by the operating company. (Also refer to SAFETY information found on pages 5 through 9)

Before crimping, ensure that crimp is within the capacity listed for the tool.

Refer to connector manufacturer's instructions for cable preparation and crimping procedure.

Ensure that you are using the proper die, as recommended by the connector manufacturer.

WARNING: DO NOT OPERATE TOOL WITHOUT DIES

1. Ensure that proper 10,000 psi power source is turned **OFF** and valve is in **OFF** position.
2. Connect to a 10,000 PSI power source with an audible "Pop Off" type relief valve. (Recommended) *Refer to page 9 UNIT/HOSE CONNECTION*
3. Ensure that the ram is fully retracted.
4. Insert proper die into die seat. *Refer to die installation on page 13.*
5. Place tool over connector. Center connector between the dies.
6. Align jaw as necessary to ensure proper crimp. Position subject at a 90° angle to the tool.

KEEP HANDS AND ALL BODY PARTS AWAY FROM COMPRESSION OPERATION

7. Turn power source "ON" and activate control valve to advance compression dies up to subject. **Check tool alignment.**
8. Continue to advance until "pop off" is felt or heard and full pressure has been obtained.
9. Use valve or double acting pump to retract dies.
10. Repeat procedure as required by compression sleeve or regulating authority.
11. Visually inspect crimp for correctness.
12. Return source to the "OFF" position and allow to retract completely.



WARNING

BEFORE USING THIS PRODUCT READ THE SAFETY WARNINGS and recommended practices described in the manual. Failure by the operator to read and fully understand the warnings will leave this person unqualified to use and operate the tool.

Failure to observe all warnings and instructions could result in property damage, severe personal injury, and/or death.

NOTE: Keep Label Set clean and legible. Replace decals when necessary.



DIE INSTALLATION

Observe safety precautions and procedures required by the operating company.

Turn flow control lever to the OFF position.

Turn hydraulic power source OFF.

Ensure crimp is within the capacity for the tool.

Refer to connector manufacturer's instructions for cable preparation and crimping procedure.

Ensure that you are using the proper die, as recommended by the connector manufacturer.

REL-LP-O, BG, or SN

INSERT "W" STYLE DIE INTO DIE RETAINER

Open tool jaw completely.

Push down on die retainer pin. (Illustration A)

Slide die half into die seat and on the die pin.

Release retainer pin.

Check to ensure die is securely seated.

Repeat steps above for opposing die half.

REL-LP-KO, or K58

INSERT KEARNEY STYLE DIE INTO JAW

Open tool jaw completely.

Slide the die into die seat. (Illustration B)

Ball detent will snap into position.

Check to ensure die is securely seated.

Repeat steps above for opposing die half.

INSERT R6 OR "W" STYLE DIES WITH D3 DIE / ADAPTER

Open tool jaw completely.

Slide the Kearney D3 die adapter into the jaw. (Illustration B) Ensure die is securely seated.

Push down on die retainer pin. (Illustration C)

Slide die half into die seat and on the die pin.

Release retainer pin.

Check to ensure die is securely seated.

Repeat steps above for opposing die half.



A. R6/W Style Die Installation

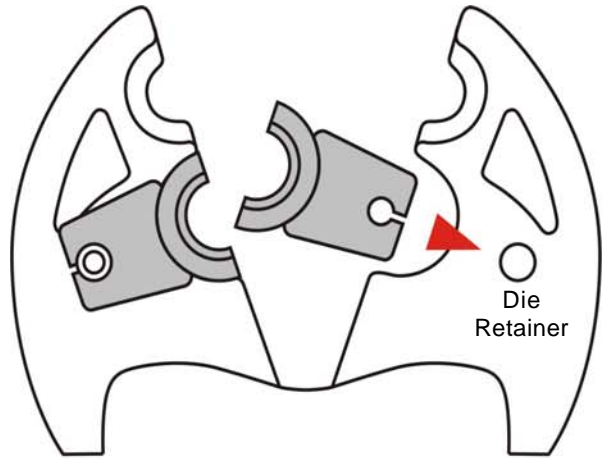

B. Kearney Style Die Installation

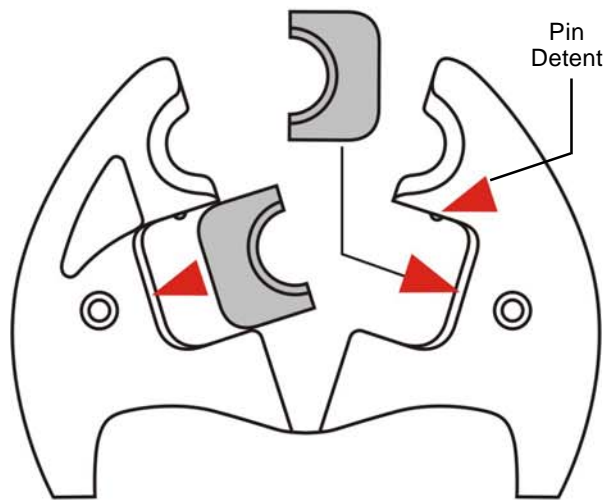

C. R6/W Die Installation with Kearney D3 Nest Die

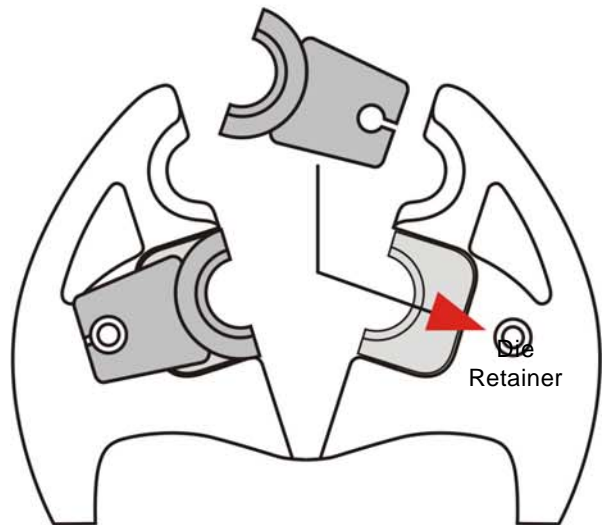

DAILY MAINTENANCE

The life, reliability, and safety of the tool is dependent on proper use and maintenance.

STORE THE TOOL PROPERLY . . . Before storing tools release pressure and ensure the ram is fully retracted. This protects the operating ram from moisture and condensation.

NOTE: When the tool has been stored for extended period of non-use, the tools should be activated approximately every 3 weeks to keep o-rings and seals lubricated.

Clean and inspect all surfaces including tool head, ram, body and connectors.

Particularly avoid joint compounds from building up on the die retainers and ram.

WARNING: Head, retainers, and/or parts may cut or pinch. Please use extreme caution.

Worn or damaged parts may malfunction during operation, causing more extensive damage to the tool and/or severe injury to the operator or bystander.

All parts must be replaced with new parts if signs of wear or damage are evident.

DO NOT MAKE ADJUSTMENTS TO THE TOOL . . . There are no adjustments on this tool which can be made in the field. If a tool becomes inoperative and the instructions in this booklet do not correct the malfunction have the tool serviced by RELIABLE EQUIPMENT or an authorized service provider.

Keep Label Set clean and legible. Replace decals when necessary.

GENERAL MAINTENANCE

Manufacturer recommends regular testing for proper pressure and operation.
Test at least every 6 (six) months, test more often under heavy usage.

This tool requires well-trained experienced personnel for major repairs, adjustments or maintenance. **Complete disassembly is not recommended. Return the unit to an authorized dealer for total disassembly and/or repair.** It is suggested that tools requiring repairs be returned to Reliable Equipment for correction unless overall local conditions are adequate and service training has been provided. Reliable Equipment is set up to provide quick maintenance and overhaul service. Contact your Reliable Equipment representative if service is required.

All maintenance or disassembly should take place on a flat, clean work surface covered with towels or wipers so as to have a clean space for the disassembled parts. Inspect each part during disassembly for wear, scratches, and cuts. Discard the worn or damaged parts and replace with new factory authorized parts.

O-rings are sensitive to sharp edges. Inspect closely for cuts or damage. A small cut will cause a leak. When assembling or disassembling O-rings, use hydraulic fluid as a lubricant to help disassembly or installation.

NOTICE: When disposing of hydraulic fluid, parts or components observe all federal, state, and local guidelines.

CRIMPING JAW SELECTION

K58 # R12891
KO # R12894

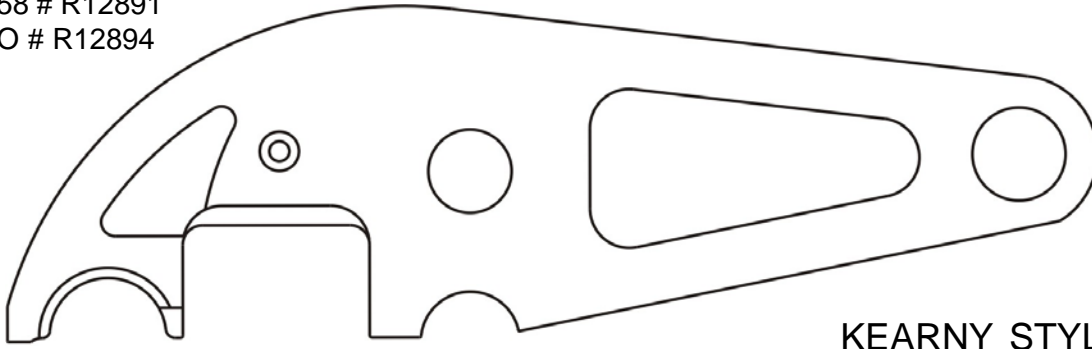

KEARNY STYLE JAW
WITH O OR 58 FIXED NOSE DIE
D3 die adapter available

"O" # R12848

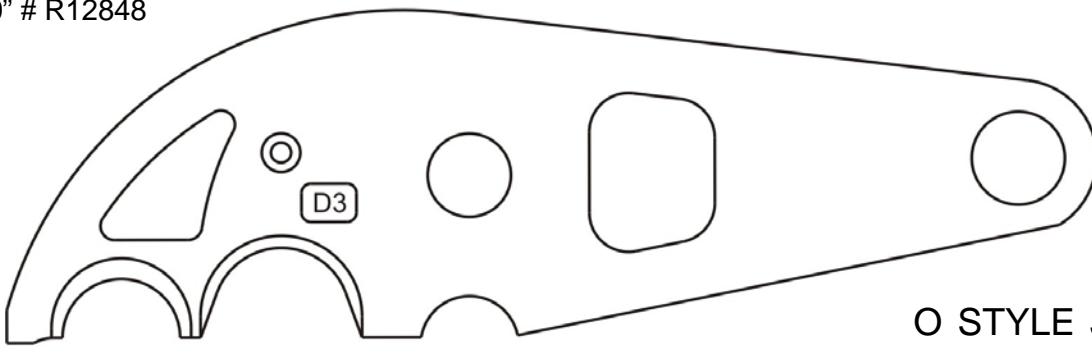

O STYLE JAW
WITH FIXED D3 SEAT

BG # R12847

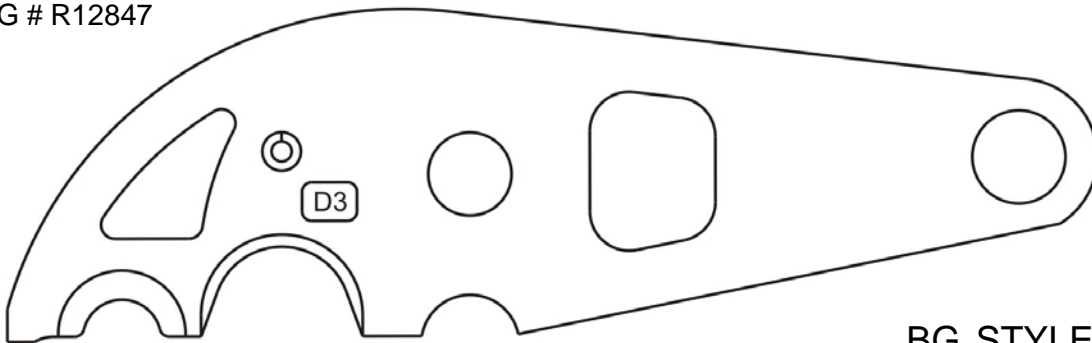

BG STYLE JAW
WITH FIXED D3 SEAT

SNUB # R12846

Access
Confined
Space

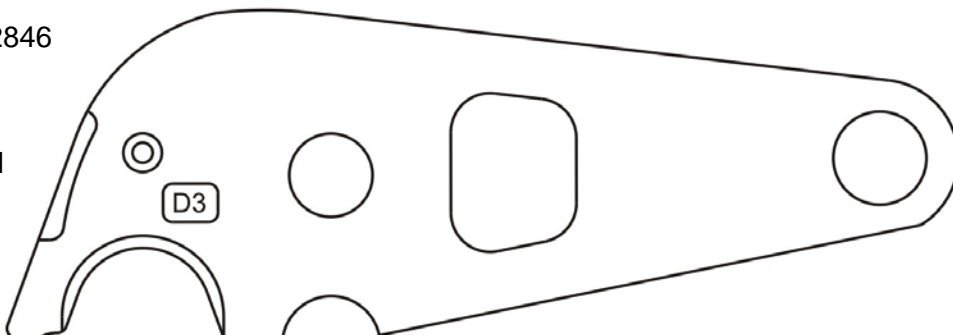

SNUB NOSE JAW WITH D3 SEAT

PDY-6.6 PARTS LIST

#	PART	QTY	PART#
1	BODY	1	R14001
2	PISTON	1	R14002
3	COLLAR	1	R14003
4	LINK	4	R14005
5	PUSH ROD	1	R14006
6	BOLT (JAW BOLT)	2	R14008
7	BUTTON HEAD SCREW (GOES IN 14001)	4	R19009
8	JAW PIN	2	R140010
9	DRIVE PIN	1	R140012
10	BACKUP RING (GOES ON 14002)	2	*
11	O-RING (GOES ON 14002)	1	*
12	O-RING (GOES ON 14003)	1	*
13	O-RING (GOES ON 14003)	1	*
14	WIPER (GOES ON 14002)	1	*
15	FLEX LOCK NUT	2	12861
16	FRAME	1	R13204
17	BOWTIE	1	12852
18	BUSHING (GOES IN JAWS AND 14006)	1	12866
19	O-RING (GOES ON 14001)	1	*
20	PIVOT PIN	1	12853
21	DIE RELEASE ASSEMBLY	1	K2854
22	SNUB NOSE JAW	2	R12846
	"BG" JAW	2	12847
	"O" JAW	2	12848
	"K58" JAW	2	12891
	"KO" JAW	2	12894
	SEAL KIT * DENOTES ITEMS IN SEAL KIT		R14025

IF YOU HAVE QUESTIONS REGARDING THE REPAIR AND MAINTENANCE OF THIS TOOL CONTACT RELIABLE EQUIPMENT OR YOUR RELIABLE EQUIPMENT REPRESENTATIVE.

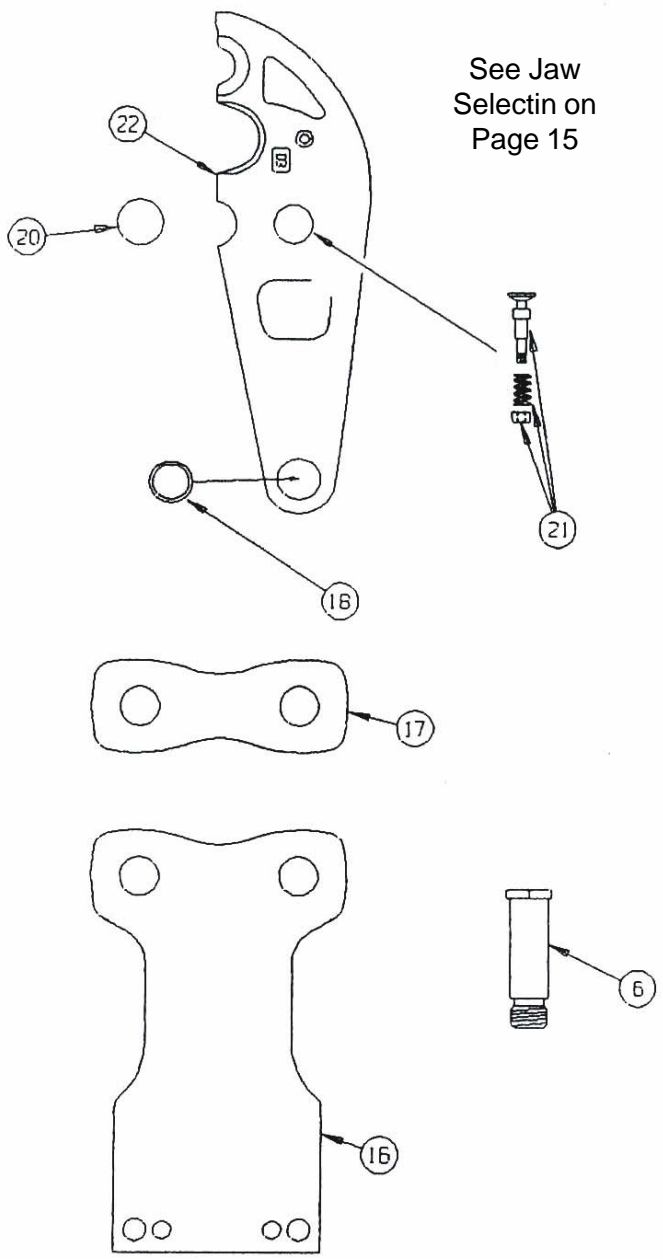
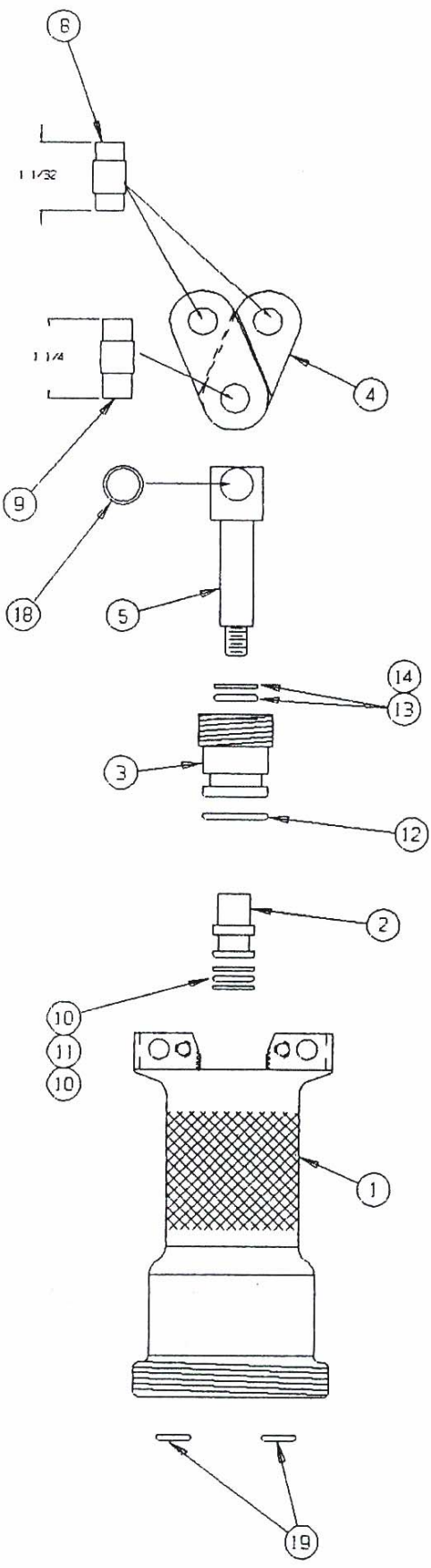

See Jaw
Selectin on
Page 15

PDY-6.6 PARTS DRAWING

