

# OPERATORS' GUIDE



Pivot style control valves may be operated with one hand, leaving the second hand free to control the head. Lever "locks" in the forward position for tool advance, and in the rear position for tool retraction. Returns automatically to center "OFF" position when rated tool pressure is reached.

#### PVA-0021 - SINGLE-ACTING CONTROL VALVE

Operate all existing single acting tools supplied with a standard 3/8" female screw type coupler.



#### PVA-0022 - D/A COUPLED CONTROL VALVE

4-way, 3-position control valve used for controlling double-acting crimping heads and cutters coupled to the tool, or use remotely with high pressure hoses.



#### PVA-1122 - D/A DIRECT CONNECT CONTROL VALVE

Open center 4-way, 3-position control valve used for controlling double-acting crimping heads and cutters. connect directly to the tool, or use with H/P hoses for remote operation.

## WARNING



All information found in this guide must be read and understood before use or testing of this tool. Failure to read and understand these warnings and safe handling instructions could result in severe personal injury and or death.

## NOTICE

Sizes, weights and tool specifications listed in this manual are subject to change without notice. Please consult factory for information and updates.

RELIABLE EQUIPMENT & SERVICE CO., INC.  
92 Steamwhistle Drive • Ivyland, PA 18974 • USA  
Phone: 215-357-3500 • Fax: 215-357-9193

MODEL: \_\_\_\_\_

SOURCE PRESSURE: 10,000 PSI

SERIAL NO.: \_\_\_\_\_

YEAR: \_\_\_\_\_



# RELIABLE EQUIPMENT & SERVICE CO., INC.

# TABLE OF CONTENTS

Registration .....	2	Intensifier Components (Fig. 1 & 2)	14
Tool Quick Reference .....	3-4	Intensifier Parts List (Fig. 1 & 2) .....	15
General Safety Issues .....	5-9	Intensifier Components (Fig. 3) ....	16
<b>SPECIFICATIONS</b>			
General Safety .....	7	3-Way Valve Assembly (Fig. 4) .....	17
Pre-Operation.....	8	Maintenance Record .....	18
Hydraulic Fluids .....	8	Phone, Fax & Address .....	18
Connections and Hoses .....	9		
Operation (Single Acting) .....	10		
Operation (Double Acting) .....	11		
<b>MAINTENANCE</b>			
General .....	12		
Before Disassembly .....	13		

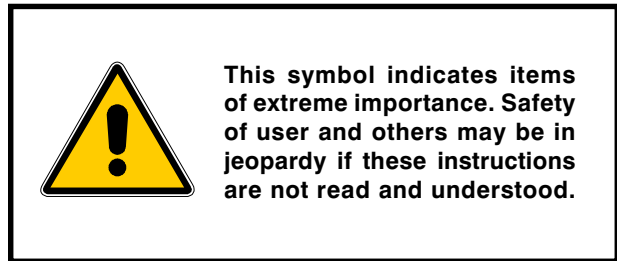

---

## REGISTRATION

UPON RECEIPT OF THIS TOOL, COMPLETE THE REGISTRATION BELOW.

COMPANY \_\_\_\_\_

ADDRESS \_\_\_\_\_

PHONE \_\_\_\_\_ FAX \_\_\_\_\_

SERIAL NUMBER \_\_\_\_\_

DATE OF PURCHASE \_\_\_\_\_

DEALER NAME \_\_\_\_\_

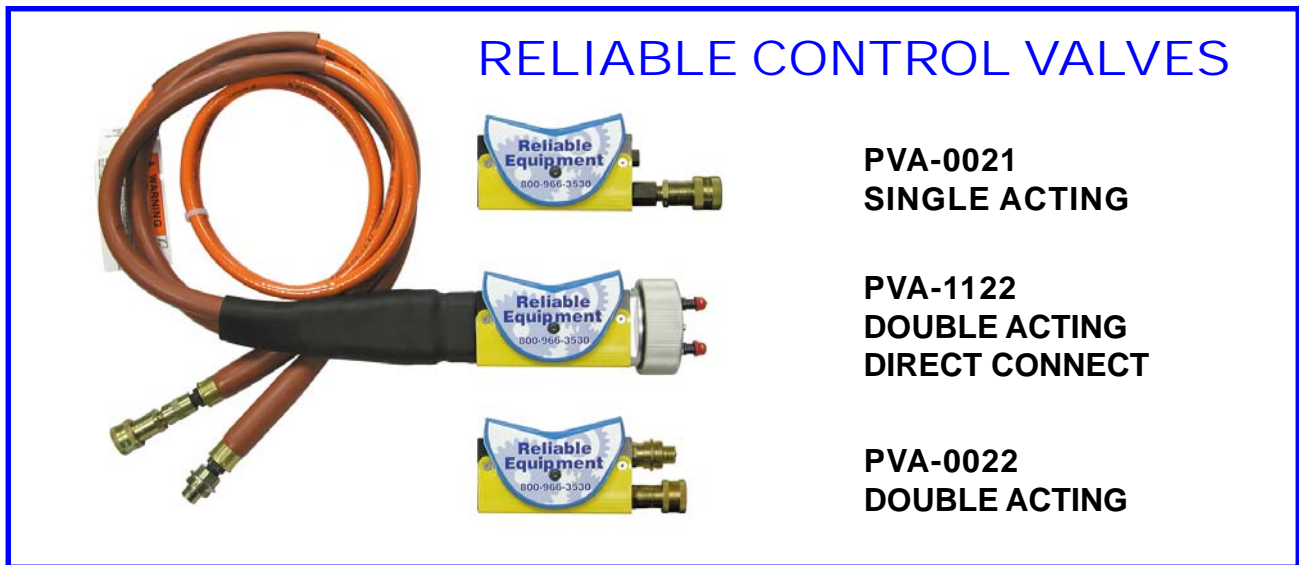

### PVA-0021 - SINGLE-ACTING CONTROL VALVE

Operate all existing single acting tools supplied with a standard 3/8" female screw type coupler. It can be converted to a Double-Acting System.

### PVA-0022 - DOUBLE-ACTING COUPLED CONTROL VALVE

### PVA-1122 - DOUBLE-ACTING DIRECT CONNECT CONTROL VALVE

Open center 4-way, 3-position control valve used for controlling double-acting Crimping Heads and Cutters. Connect directly to the tool or use with high pressure hoses for remote operation. The Pivot Style Control Valve may be operated with one hand, leaving the second hand free to control the head. Lever "locks" in the forward position for tool advance, and in the rear position for tool retraction. Returns automatically to center "OFF" position when rated tool pressure is reached.

The Ground Dump Safety Valve, a standard feature, will activate if the return line is not connected. It protects the system by dumping the flow into the atmosphere.

**Weight 2.5 lb.** (PVA 1122 is 3 lb. W/ Coupler), **Length 7"**, **Width 2"**, **Height 3.5"**

### FEATURES:

- **Compact Design**
- **Controlled Advance with Built-in Hold Feature**
- **Tool Return Circuit 5,000 psi Return Line**
- **6,200 psi Return Line Ground Dump Safety Valve**

SPECIFICATIONS	PVA 0021	PVA 0022	PVA 1122
System	Single-Acting	Double-Acting	Double-Acting
Max. Oper. Pressure	10,000 psi	10,000 psi	10,000 psi
Return Pressure	N/A	5,000 psi	5,000 psi
Port Size (Inlet)	1/4-18 NPTF	1/4-18 NPTF	1/4-18 NPTF
Port Size (Tool)	1/4-18 NPSM	1/4-18 NPSM	1/4-18 NPSM
Couplers	H/P 10,000 psi Quick Connect	H/P 10,000 psi Quick Connect	Direct Connect

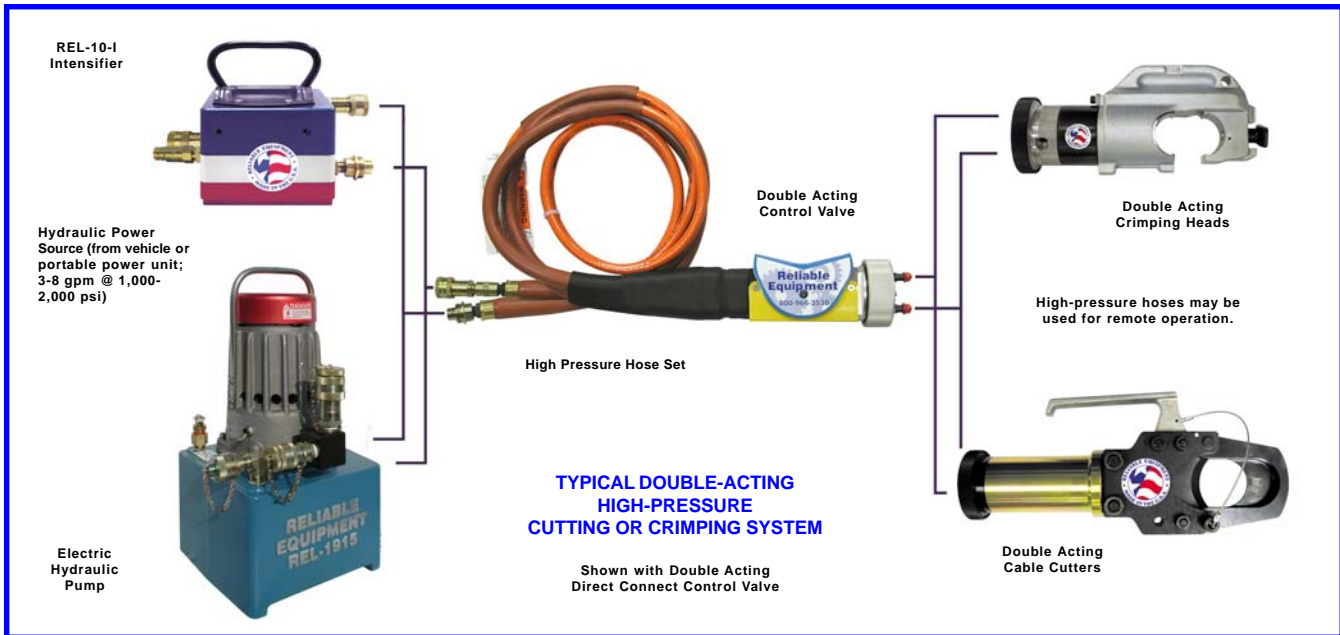

## DOUBLE-ACTING TOOLS ARE BUILT TO PROVIDE SAFETY, QUALITY AND RELIABILITY IN EVERY STEP OF HIGH PRESSURE TOOL OPERATION.

In most cases, double-acting tools are lighter and more compact than comparable crimping and cutting equipment, insuring easier and safer use. This is especially important in compact working areas and hot stick use when every ounce of a tool's weight is felt by the operator.

The one-hand valve operation is safer and easier to use, leaving your other hand free to control the tool head. Each valve has two pressure reliefs for extra safety: One to reduce the return cycle pressure to prevent damage to the tool; The second to protect against over pressurizing.

### DOUBLE-ACTING HYDRAULIC SYSTEM

**Superior Performance** - beats competitive power tool systems on key features and benefits.

**Better tool control** - start, stop, feather, and position your crimping or cutting head with ease.

**No die hang-ups** - crisply retracts the die after every crimp.

Compatible with many existing tool and die inventories or convert your existing tools and dies to our double-acting system.

**Consistent Pressure** - Delivers up to 10,000 psi at tool head, regardless of positioning.

**Quality Features** - Lightweight, built-in pressure reliefs; ground dumps; scavenger pump reduces back-pressure problems; one-hand valve operation; and certified non-conductive hoses.

**Portability** - Lighter and more streamlined than most other tools.

**Adaptability** - Use Reliable tools with your truck's existing system or one of our portable power units.

### VALVES

Reliable valves feature one-hand operation for extreme ease of use. They can be direct-coupled to the tool or, if you wish, attached with hoses for remote operation. In addition, they feature a built-in relief valve to limit tool return pressure and a ground dump safety valve to prevent over pressurizing in case the return hose becomes disconnected or plugged.

### CRIMPING HEADS

In many cases, double-acting crimping heads are significantly lighter than competitive models. Safety is designed-in as well. One example: A pressure reducing cavity is designed into each head to reduce the risk of personal injury from a high-pressure oil leak.

### CUTTERS

All cutters are double-acting and available in capacities from 1/2 in. to 4 in. Some models can handle a wide range of materials, including rebar, ACSR, guy strand, and bolts. Other safety features include hoses rated at four times the working pressure, and dielectrically safe hoses.



**WARNING**

BEFORE USING THIS TOOL, READ THE WARNINGS and the recommended practices described in this manual. Failure by the operator to read and fully understand these warnings will leave this person unqualified to use and operate this tool. Property damage, severe personal injury, and/or death could result by not following these warnings.

These warnings will appear in appropriate locations when they are pertinent to the particular subject being shown. Read each one carefully and follow them strictly.



**Eye Protection**

**WARNING**

Always wear eye protection to avoid injury from flying debris or hydraulic oil leaks. Failure to do so can result in serious personal injury.



**Skin Irritation**

**WARNING**

Hydraulic oil may cause irritation. Use care to prevent contact with skin. In case of accidental contact, wash affected area immediately



**Hard Hat**

**WARNING**

Always wear a hard hat to avoid injury from falling debris. Failure to do so can result in serious personal injury.



**Foot Protection**

**WARNING**

Always wear foot protection. Failure to do so can result in serious personal injury.



**Hearing Protection**

**WARNING**

Always wear hearing protection, to avoid hearing loss due to long term exposure to high noise levels.



**Protective Gloves**

**WARNING**

Always wear protective gloves Failure to do so can result in serious personal injury.



**WARNING**

## Safe Operation & Care

**USE THIS TOOL FOR ITS INTENDED PURPOSE ONLY**

Any other use can result in injury or property damage.

**INSPECT TOOL BEFORE USE.** Replace any worn, damaged or missing parts. A damaged or improperly assembled tool may malfunction, injuring operator and/or nearby personnel.

**INSPECT HYDRAULIC HOSES AND COUPLINGS** before each use. Repair or replace if any cracking, leakage, wear or damage is found. Worn or damaged hoses may fail resulting in personal injury or property damage.

**CLEAR WORK AREA** of all bystanders and unnecessary personnel before operating this tool.

**KEEP ALL PARTS OF THE BODY AWAY FROM MOVING PARTS.**

Failure to observe this warning could result in serious injury.



**WARNING**

## Safety

**DO NOT** attempt to make any changes to any of the component parts or accessories when connected to the power source.

**DO NOT** adjust, inspect, or clean tool while the tool is connected to the power source. The tool could accidentally start up and cause serious injury.

**DO NOT** lock the tool in the On Position. In an emergency, serious damage or injury could occur during the time required to stop the tool.



**WARNING**

## Oil Injection Injury

Hydraulic oil or fluid under the skin is a serious injury. Oil under pressure can penetrate the skin and may cause dismemberment or loss of life. Seek medical assistance immediately if such an injury should occur.

Always wear safety gloves, eye protection and all required safety equipment when operating or handling this tool.

**DO NOT** use fingers or hands to attempt to locate a leak.

**DO NOT** handle hoses or couplers while system is pressurized.

**NEVER** open or service the system before depressurizing.





**WARNING**

## Burn Hazard

Do Not connect or disconnect tool, hoses or fittings while power source is running or while hydraulic fluid is hot. Hot hydraulic fluid may cause serious burns.

Failure to observe this warning could result in serious injury.



**WARNING**

## Electrical Shock Hazard

Use only certified nonconductive hoses and fittings. Always wear and use the necessary clothing, equipment and safety practices to protect against electrical shock. Failure to follow these rules can result in serious personal injury or death.



**CAUTION**

## Safe Handling

HYDRAULIC FLUID MAY CAUSE SKIN IRRITATION.

Prevent hydraulic fluid from making contact with skin.

IN THE EVENT OF SKIN CONTACT immediately wash thoroughly.

Failure to observe this warning could result in injury.



**CAUTION**

## General Safety

Ensure that all fellow employees and bystanders are clear and protected from possible injury caused by this tool or the operations being performed. Persons in close proximity could be injured and property damaged if the tool were to malfunction.

This tool should always be used within the limits and purposes stated by the product manufacturer. Abuse or usage beyond the manufacturers' intended purposes could cause damage to the tool and severe injury to the operator.



**CAUTION**

The information in this manual is intended to guide the user in the use and application of this tool. It is not intended as a substitute for proper training and experience in safe work practices for this type of equipment.

Consult your supervisor or safety personnel if you have any questions regarding the safe operation of this tool.

# PRE-OPERATION OF TOOL



**WARNING**

**DO NOT** connect hoses or fittings to pump before reading all of the instructions in this section.

Ensure power source is **OFF**, hydraulic flow is turned **OFF**.

Failure to comply with this warning can result in severe injury or death.

Before attempting to run or use the REL-10-I-SA or connected tools, check all connections, including hoses, and couplings. (See WARNINGS on pages 4-6)

Wear all safety items required, and make sure that the working area is clear of obstructions and non-essential personnel.

## HYDRAULIC FLUIDS

All hydraulic fluids that meet these listed specifications or the listed HTMA specifications may be used for this tool.

**S. U. S.**

@ 100° F (38° C) ..... 140 TO 225

@ 210° F (99° C) ..... 40 minimum

**FLASH POINT** ..... 340° F min. (170° C min.)

**POUR POINT** ..... -30° F min. (-34° C min.)



**WARNING**

## HOSES AND FITTINGS

There exists the potential for shock in using anything other than certified nonconductive hoses and hydraulic oil with dielectric properties, when using system components near energized electrical lines. Failure to recognize these conditions could cause electrocution.

**Hoses and fittings used with this tool must comply with S.A.E. J1273** which covers recommended practice for selection, installation, and maintenance of hose and hose assemblies. The **correct hoses and fittings are available from your supplier.**

**WARNING:** Failure to comply with these warnings could result in severe bodily injury.

## NOTICE

If you have any questions regarding the information found in this manual please contact the supervising authority, or **RELIABLE EQUIPMENT** before continuing.  
Phone: 215-357-3500 • Toll Free: 800-966-3530 • Fax: 215-357-9193





**WARNING**

## **UNIT/HOSE CONNECTIONS**

**ALWAYS DISCONNECT** hydraulic source and move valve handle to **RETRACT** before connecting or disconnecting any components.

**ALWAYS DEPRESSURIZE** hydraulic system, before slowly connecting/disconnecting this unit or any of the systems components.

**ALWAYS TIGHTEN** couplings completely. Loose or improperly tightened couplings will not allow fluid to pass through the hose creating a blockage in the supply or return line.

**ALWAYS INSPECT HOSES AND CONNECTORS** before connection to tool. Replace or repair if any leakage is evident. Leakage is a sign of deterioration in component parts. Worn or leaking parts must be repaired or replaced. Tool damage or severe injury could result.



**CAUTION**

## **HOSE INSTALLATION**

1. **ENSURE POWER SOURCE IS OFF AND OIL HAS COOLED.**
2. **ENSURE HYDRAULIC FLOW IS TURNED OFF.**
3. ALWAYS ENSURE CONNECTORS ARE CLEAN.
4. CONNECT HOSES TO HYDRAULIC SUPPLY.
5. ENSURE THAT THE VALVE IS IN THE RETRACT POSITION.
6. CONNECT THE REL-10-I-SA INTENSIFIER.
7. ENSURE THAT THE VALVE IS IN THE RETRACT POSITION.
8. CONNECT THE HOSE TO THE PRESSURE PORT ON THE REL-10-I-SA, THEN CONNECT TO THE PORT ON THE TOOL.



**CAUTION**

## **DISCONNECTING HOSES**

**Turn OFF hydraulic source, ensure valve handle is in the RETRACT position and oil has cooled before disconnecting the hydraulic source, tool, or hoses.**

Disconnect hose from the REL-10-I-SA, before disconnecting the tool. Disconnect the pressure hose from the pressure “P” port on the hydraulic source, then disconnect the hose from the pressure port on the REL-10-I-SA.

Disconnect the return hose from the return “T” port on the REL-10-I-SA, then disconnect the hose from the return (tank) port on the source.

Install dust caps on all connectors to prevent dirt and contaminants from entering the hydraulic system.

**WARNING:** Failure to comply with these warnings may result in severe bodily injury.

# SINGLE ACTING OPERATION

**USE APPROPRIATE AND APPLICABLE PERSONAL SAFETY PROCEDURES AND EQUIPMENT AS REQUIRED BY THE OPERATING COMPANY.**

Inspect, set-up and connect the tool as described on the previous pages.

**NOTE: AN IN LINE VALVE IS REQUIRED FOR DOUBLE ACTING OPERATION.**

WARNING: **DO NOT** connect or disconnect the tool, hoses, or fittings while the tool is running, hot, or under pressure.

**Tool damage, serious injury or burns may result.**

Replace all parts that show signs of wear or damage.

Damaged or improperly assembled tool may injure operator and/or nearby personnel.

Set up desired operation. (ie. crimp, cut, or spearing).

Review and understand all operation and safety guidelines relating to the operation to be performed.

Ensure that valve is in the **CENTER/NEUTRAL** position before initiating hydraulic source.

Activate the **tool** by moving valve treadle to the **FORWARD/ADVANCE** position.

Operate control valve to activate tool and begin cutting or crimping procedure.

When relief valve popping occurs desired pressure has been achieved and operation should be complete.

NOTE: Holding control valve in the ADVANCE position after relief valve has popped will cause unnecessary wear on relief valve and pump assembly.

Tool jaw/blades will return to the open position.

Repeat operation as necessary.

Move valve handle to **NEUTRAL** to stop pressure.

Valve should be in **NEUTRAL** position when not in use.

WARNING: **ALWAYS** ensure valve handle is in the neutral position and hydraulic source is turned off before you connect or disconnect the tool, hoses, or fittings while the tool is running, hot, or under pressure.

**Serious property damage, injury, or burns may result.**

## NOTICE

If you have any questions regarding the information found in this manual please contact the supervising authority, or **RELIABLE EQUIPMENT** before continuing.

Phone: 215-357-3500 • Toll Free: 800-966-3530 • Fax: 215-357-9193

# DOUBLE ACTING OPERATION

**USE APPROPRIATE AND APPLICABLE PERSONAL SAFETY PROCEDURES AND EQUIPMENT AS REQUIRED BY THE OPERATING COMPANY.**

Inspect, set-up and connect the tool as described on the previous pages.

**NOTE: AN IN LINE VALVE IS REQUIRED FOR DOUBLE ACTING OPERATION.**

WARNING: **DO NOT** connect or disconnect the tool, hoses, or fittings while the tool is running, hot, or under pressure.

**Tool damage, serious injury or burns may result.**

Replace all parts that show signs of wear or damage.

Damaged or improperly assembled tool may injure operator and/or nearby personnel.

Set up desired operation. (ie. crimp, cut, or spearing).

Review and understand all operation and safety guidelines relating to the operation to be performed.

Ensure that valve is in the **CENTER/NEUTRAL** position before initiating hydraulic source.

Activate the **tool** by moving valve treadle to the **FORWARD/ADVANCE** position.

Operate in-line control valve to activate double acting tool and begin cutting or crimping procedure. When relief valve popping occurs desired pressure has been achieved and operation should be complete.

NOTE: Holding control valve in the ADVANCE position after relief valve has popped will cause unnecessary wear on relief valve and pump assembly.

Move valve treadle to the **REVERSE/RETRACT** position to open tool jaw/blade.

Return valve treadle to **NEUTRAL** position.

Repeat operation as necessary.

Upon completion move valve handle to **Neutral** to stop pressure.

Valve should be in **Neutral** position when assembly is not in use.

WARNING: **ALWAYS** ensure valve handle is in the neutral position and hydraulic source is turned off before you connect or disconnect the tool, hoses, or fittings while the tool is running, hot, or under pressure.

## NOTICE

If you have any questions regarding the information found in this manual please contact the supervising authority, or **RELIABLE EQUIPMENT** before continuing.  
Phone: 215-357-3500 • Toll Free: 800-966-3530 • Fax: 215-357-9193

**Serious property damage, injury, or burns may result.**

# SCHEDULED MAINTENANCE

The life, reliability, and safety of the tool is dependent on proper maintenance.

## DAILY MAINTENANCE

**Clean** all surfaces including, hand control, fittings, hoses and housing.

**Inspect** tool for wear and damage. Worn or damaged parts may cause malfunction.

**Inspect** for cracked hoses and leaking fittings.

**Check** fluid level of the power source reservoir frequently.

**All the above items must be replaced with new parts if signs of wear are evident.**



**IMPORTANT:** The greatest cause of hydraulic pump/valve failure is dirt. Prevent the introduction of foreign matter into the unit via hydraulic fluid, dirty connections or accumulation of sediment.

**FLUID CONTAMINATION:** Cover the ends of fittings with a dust cap when disconnected. This will help keep the fluid from contamination.

**MONTHLY MAINTENANCE:** Inspect per Appendix A, SAE Standard J1273, 5/86 for hose or fitting damage such as wear, cracks or leakage; replace the necessary parts.



### WARNING

BEFORE USING THIS PRODUCT READ THE SAFETY WARNINGS and recommended practices described in the manual. Failure by the operator to read and fully understand the warnings will leave this person unqualified to use and operate the tool.

Failure to observe all warnings and instructions could result in property damage, severe personal injury, and/or death.

### CAUTION

Operation and safety methods may vary in accordance with the guidelines established by each utility. For your safety, ensure that you fully comply with all safe operation guidelines established by your respective power utility. REL-SM

### DANGER

The user should be properly trained in the correct procedures required for work on or around electrical lines.

# **READ BEFORE DISASSEMBLY**

**NOTE:** Keep Label Set clean and legible. Replace decals when necessary.

**Complete disassembly is not recommended.**

Return the unit to an authorized dealer for total disassembly and/or repair.

All maintenance or disassembly should take place on a flat, clean work surface covered with towels or wipers so as to have a clean space for the disassembled parts.

Inspect each part during disassembly for wear, scratches, and cuts. Discard the worn or damaged parts and replace with new parts.

**Use only factory specified parts when repairing and/or replacing.**

**Severe damage to the tool can occur with non-specified parts.**

O-rings are sensitive to sharp edges. Inspect closely for cuts or damage. A small cut will cause a leak. When assembling or disassembling O-rings, use hydraulic fluid as a lubricant to help disassembly or installation.

The unique plumbing required to integrate the **REL-10-I** with the **PVA-00L3** 3-way valve is custom fitted for each unit, and cannot be purchased for non-factory repairs at this time.



**WARNING**

## **Safety**

**DO NOT attempt to make any changes to any of the component parts or accessories when connected to the power source.**

**DO NOT adjust, inspect, or clean tool while the tool is connected to the power source. The tool could accidentally start up and cause serious injury.**



**WARNING**

Before disassembly, disconnect hoses as described in this manual. Any residual pressure within the unit can and will spray at high velocity, injuring the person doing the disassembly. Hot or pressurized hydraulic fluid will cause serious injury or death.

**Complete disassembly is not recommended. Return the unit to an authorized dealer for total disassembly and/or repair.**

## **NOTICE**

If you have any questions regarding the information found in this manual please contact the supervising authority, or **RELIABLE EQUIPMENT** before continuing.  
Phone: 215-357-3500 • Toll Free: 800-966-3530 • Fax: 215-357-9193

# PVA VALVE BODY - DRAWING # 1

**WARNING !**  
**DO NOT ADJUST !**  
 FACTORY SET RELIEF VALVES  
 INCORRECT ADJUSTMENT MAY  
 RESULT IN PERSONAL INJURY

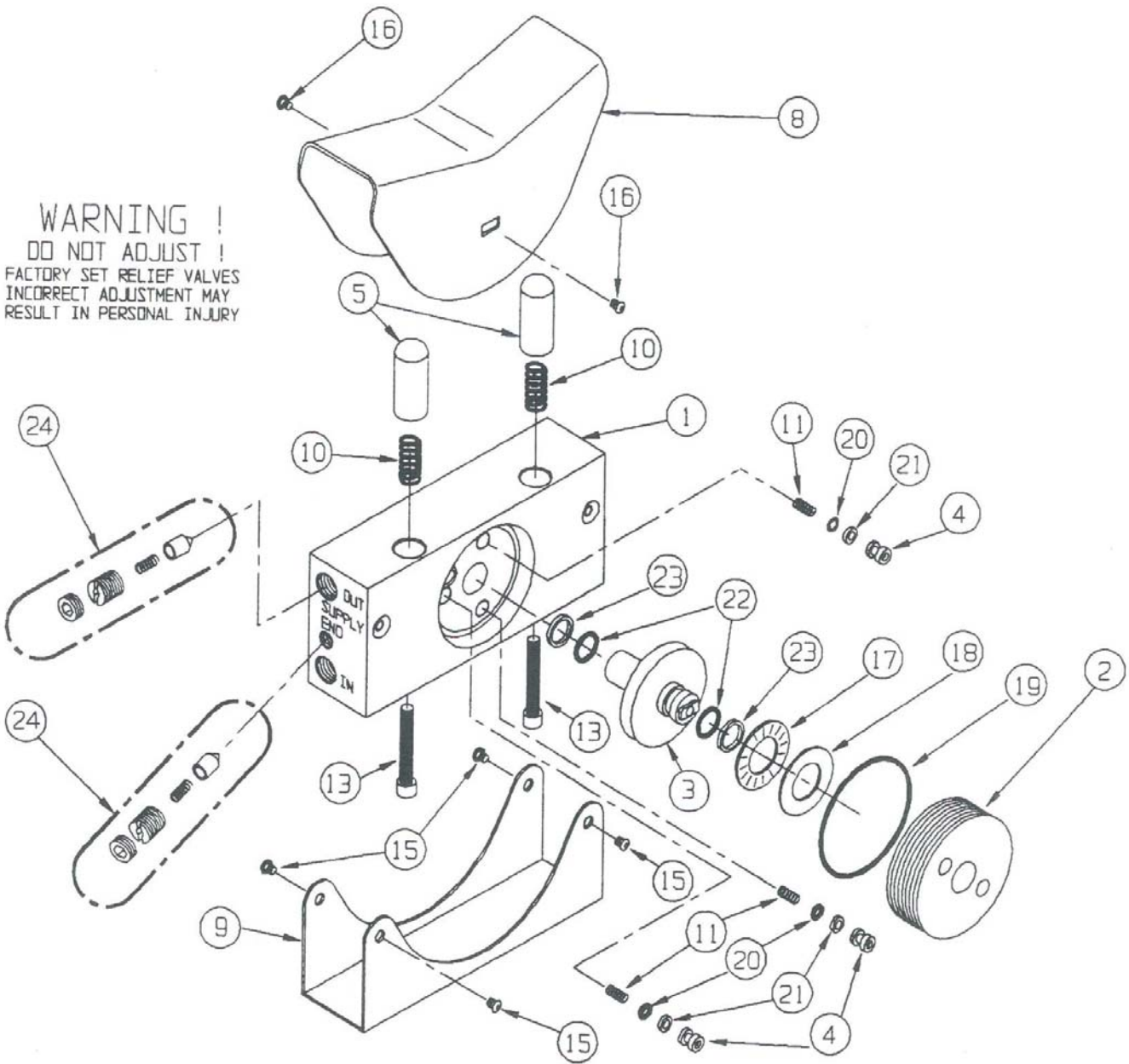

## PVA VALVE OPTIONS

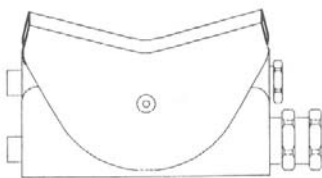

PVA0021A SINGLE ACTING

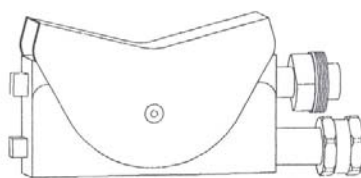

PVA0022A DOUBLE ACTING

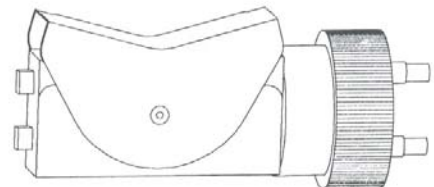

PVA1122A DIRECT CONNECT DOUBLE ACTING



**PARTS LIST FOR PVA 4 WAY VALVE**

<b>ITEM</b>	<b>REQD</b>	<b>PART NO.</b>	<b>DESCRIPTION</b>
1	1	12950	VALVE BODY
2	1	12951	CAP
3	1	12952	ROTOR
4	3	12954	GROMMET
5	2	12955	PLUNGER
6	2	12956	PINTLE
7	2	12957	ADJUSTING CAP
8	1	12958	TREADLE
9	1	12959	POLY COVER
10	2	12960	SPRING, PLUNGER
11	3	12961	SPRING GROMMET
12	2	12962	SPRING, PINTLE
13	2	12963	SCREW, PLUNGER
14	2	12964	JAM SCREW
15	4	12965	POLY COVER SCREW
16	2	12966	TREADLE SCREW
17	1	12967	THRUST BEARING
18	1	12968	THRUST WASHER
19*	1	12969	O`RING
20*	3	12970	O`RING, GROMMET
21*	3	12971	BACKUP RING
22*	2	12972	O`RING, SHAFT
23*	2	12973	BACKUP RING
24	2	K2956	KIT, REL. VALVE ASSY
25	1	K2969	SEAL KIT
26	1	12977	3/16X5/8 PIN

ITEMS MARKED \* ARE CONTAINED IN SEALKIT K2969

**DIRECT CONNECT ASSY**

27	1	12112	RETAINING RING
28	1	12103	RETAINING NUT
29	1	12144	BODY
30*	2	12145	O`RING
31*	2	12146	BACKUP RING
32	2	12149	BAYONET PIN
33	1	12148	LOCATING PIN
34	2	12153	VINYL NIPPLE
35	1	K2946	SEAL KIT

ITEMS MARKED \* ARE CONTAINED IN SEAL KIT K2946

## MAINTENANCE RECORDS

Date	Parts or Service Required

If you have any questions regarding the information found in this manual please contact RELIABLE EQUIPMENT at the address, phone or fax numbers shown below.



**RELIABLE EQUIPMENT  
& SERVICE CO., INC.**

92 Steamwhistle Drive • Ivyland, PA 18974  
Phone: 800-966-3530 • Fax: 215-357-9193  
Visit us on the web at [www.Reliable-Equip.com](http://www.Reliable-Equip.com)